

EXPERT KNOWLEDGE **TEST PROCEDURES** **OF ELASTOMER COMPONENTS**

An offer of

O RING
PRÜFLABOR
RICHTER

O RING

TESTING CONSULTING DEVELOPING

Source: www.o-ring-prueflabor.de

Information as of 10/2014

Tensile Test– **Test Engineering Basics and** **Recommendations for Practical Application**

RICHTER

Authors:
Dipl.-Ing. (FH) Ulrich Blobner,
Dipl.-Ing. Bernhard Richter

Test standards used: DIN 53504 (Edition 10-2009), ISO 37 (Edition 12-2011), VDA 675 205 (Edition 12-1992), ASTM D412 06a (Reapproved 2013), ASTM D1414 94 (Reapproved 2008)

1. Definition of the Tensile Test

During the tensile test, standardized test specimens (in most cases dumbbell specimens) are clamped in a tensile testing machine and stretched at a constant feed rate until they tear. During this process, the course of the required force and elongation is recorded and a tensile elongation diagram is generated. Important individual parameters are tensile strength at break and elongation at break. It is also a helpful instrument for making comparative conclusions between non-preloaded, new and aged materials.

O-Ring Prüflabor Richter GmbH
Kleinbottwarer Str. 1
71723 Großbottwar

Telefon 07148 / 16602-0
Fax 07148 / 16602-299
info@o-ring-prueflabor.de
www.o-ring-prueflabor.de

Geschäftsführer:
Dipl.-Ing. Bernhard Richter
Ust-ID-Nr. DE 277600966
Steuer-Nr. 71342/02407 FA LB

Sitz der Gesellschaft:
Großbottwar
Amtsgericht Stuttgart
HRB 737482

Volksbank Ludwigsburg
IBAN DE96 6049 0150 0820 5810 03
SWIFT GENODES1LBG

2. Purpose of Tensile Testing - Practical Benefits

The following sections will demonstrate why tensile testing is a very conclusive test method that can be used to obtain very different, varied and helpful information about materials and finished parts.

2.1 Statements About the Mechanical Load-Bearing Capacity (Elongation, Strength)

The results from the tensile test are in many cases of less interest to the designer at first glance since elastomers are rarely subjected to permanent tensile strain. However, it should not be forgotten that large expansions can occur during the assembly process. This can result in expansions of more than 100%. Moreover, a high elongation at break in the case of highly compressed seals results in greater resistance to stress cracking. It prevents the gasket from bursting inside due to the high deformation. However, high tensile strength also has application benefits in terms of improved abrasion resistance and greater resistance to gap extrusion.¹

If compounds with higher strength values exist within the same polymer family, this often indicates better and higher quality compound components. However, it must be checked in detail whether this higher strength is actually required for the specific application. If there are several similar elastomer compounds to choose from for an application, the tensile strength should rarely be the decisive selection criterion. Other characteristic values are much more important, such as compression set or aging in hot air or mediums, which are also determined with the aid of tensile tests.

When drawing up material specifications, care should be taken not to demand unnecessarily high tensile strengths and elongation at break. These could perhaps be achieved by an experienced compounder and high-quality compound components, but mostly at the expense of other more important material parameters and process-ability or price.

2.2 Statements About the Formulation and Processing Quality of a Material

According to DICK², the tensile test provides the quality assurance engineer with information as to whether the compound has been thoroughly mixed and dispersed, whether impurities due to foreign particles such as dirt or paper are present, whether the material has been over- or under-cross-linked, or whether porosities are present. If, for example, carbon black particles are not sufficiently dispersed, carbon black agglomerates may occur, which can cause premature tearing of the test specimens. Porosities usually arise during tempering due to volatile components in the mixture. Due to all these possible errors, it is common in the rubber industry to carry out a batch test (tensile strength and elongation at break) during series production.

It is not always easy to find out whether problems are due to poor compound quality or poor processing quality (e.g. injection molding or pressing). Sometimes the tensile test is not sufficient and other test and analysis methods have to be considered.

Finally, it is important for the practitioner to know that laboratory compounds normally have

¹ This only applies in combination with other material properties such as hardness, good tear resistance and compression set.

² DICK, John S.: Rubber Technology – Compounding and Testing for Performance, München, 2001, S.49

better tensile strengths than production-scale compounds because the former are more thoroughly dispersed. This means that the tensile strengths measured on finished parts may be lower than the values measured on test plates for material release, because test plate mixtures are often produced in the laboratory.

2.3 Lifetime and Mechanical and Chemical Resistance of Materials / Load Limits (Aging)

In order to obtain information about the service life of materials, aged test rods are compared with production-fresh ones. Aging takes place either by air or specific test mediums (e.g. oils, fuels, hot water, etc.) at elevated temperatures. Of primary interest here are the percentage changes in the test parameters tensile strength and elongation at break, which provide information about the network structure. The percentage changes indicate the extent to which the three-dimensional network is damaged.

Long test durations and correspondingly adapted test temperatures can also be used to simulate lifetime loads.

These tests are carried out both within the framework of material development and during release testing in accordance with the specifications of seal users (e.g. OEMs in the automotive sector).

With the help of the tensile test, the compound developer obtains information about cross-linking systems and interactions of various compound components, e.g. active carbon black or fillers. Many compounders usually work with the aid of statistical design of experiments (DoE). The results from the tensile test are usually a very important parameter here.

2.4 Determination of Material Characteristics for Numerical Calculations

Computer simulations are also playing an increasingly important role in the elastomer industry. In contrast to many other materials, however, the calculation of elastomers is a very complex field, since the thermoviscoelasticity of rubber materials and other important properties of a compound strongly depend on the respective compound and application temperature and cannot be easily calculated and described. As can quickly be seen from the force/elongation curves, the properties of elastomers are not linear, which requires more complicated calculation algorithms.

Moreover, in contrast to the plastics industry³, there is a much larger number of different elastomer compounds, so that in very few cases formulation-specific material databases can be used for the calculation.

In order to obtain the material model of a mixture, a comprehensive determination of the respective material characteristics is necessary, depending on the problem at hand. The tensile test (partly also with temperature chamber) is one of several important test methods.^{4 5}

³ In the plastics industry, for example, the material data of the most important types of plastics are available on the Internet in the CAMPUS database: <http://www.campusplastics.com/campus>. Some of these data can also be used for calculations.

⁴ <http://www.axelproducts.com/pages/hyperelastic.html> (Webseite abgerufen am 09.07.2014)

⁵ <http://www.axelproducts.com/downloads/TestingForHyperelastic.pdf> (Webseite abgerufen am 09.07.2014)

Structural-mechanical simulations (simulation of material aging⁶ and lifetime estimations)⁷ as well as calculations can then be carried out, which are of great use in the development⁸ and optimization of elastomer components.⁹

2.5 Statements on Polymer-Filler Interactions

In the non-linear stress / strain curve, which often has an alternating point, the effect of the reinforcing fillers is reflected among other aspects. While in the first more strongly rising part of the curve, polymer chains primarily are stretched. In the flattening part, the partial detachment of the polymer from the filler can be seen. Further details can be found in section 5.2.6 of this article.

3. Important Test Standards for Tensile Tests: Description of the Test Procedure and Important Characteristic Values

The ISO 37 and DIN 53504¹⁰ standards most frequently used in our everyday laboratory work define testing on standard test specimens.

3.1 Standardized Specimens

Dumbbell-shaped test specimens, so-called dumbbell bars, are most frequently used. These are usually punched out of vulcanized elastomer test plates. The following table gives an overview of the most important key data of these test bars.

⁶ vgl. ACHENBACH, Manfred: Modellierung der Alterung von Gummi in: STREIT, Gerhard (Hrsg.): Elastomere Dichtungssysteme, Expert Verlag, Renningen, 2011, S.291ff.

⁷ vgl. ACHENBACH, Manfred: Modell zur Thermoviskoelastizität von Elastomeren: Modelle zur Beschreibung des thermo-mechanischen Eigenschaftsprofils von elastomeren Dichtungsmaterialien und ihre Verwendung in Finite Elemente Simulationen von Dichtungssystemen in: STREIT, Gerhard (Hrsg.): Elastomere Dichtungssysteme, Expert Verlag, Renningen, 2011, S.213ff.

⁸ vgl. ACHENBACH, Manfred und BOSCHET, René: Auslegungen von Dichtungen mit der FEM in: STREIT, Gerhard (Hrsg.): Elastomere Dichtungssysteme, Expert Verlag, Renningen, 2011, S.321ff.

⁹ STOMMEL, Markus und STOJEK, Marcus und KORTE, Wolfgang: FEM zur Berechnung von Kunststoff- und Elastomerbauteilen, Carl Hanser Verlag, München, 2011

¹⁰ The content of DIN 53504 (edition 10-2009) was largely adapted to ISO 37 from 2005. This technical article will mainly deal with ISO 37, with cross-references to special features and deviations in DIN 53504.

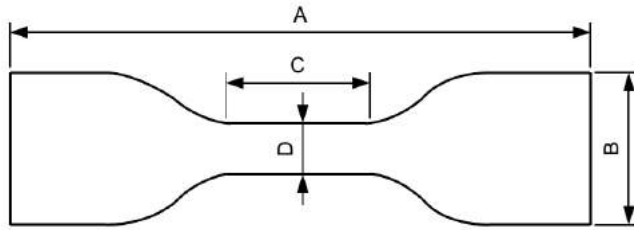

Fig. 1: Sketch of a dumbbell bar: the designation of the distances is taken from ISO 37.¹¹

Dimensions [mm]	Dumbbell Bar				
	Type 1	Type 1A	Type 2	Type 3	Type 4
Total Length A	115	100	75	50	35
Head Width B	25 ± 1	25 ± 1	12.5 ± 1	8,5 ± 0.5	6 ± 0.5
Bridge Length C	33 ± 2	21 ± 1	25 ± 1	16 ± 1	12 ± 0.5
Bridge Width D	6.2 ± 0.2	5 ± 0.1	4 ± 0.1	4 ± 0.1	2 ± 0.1
Dumbbell Thickness	2 ± 0.2	2 ± 0.2	2 ± 0.2	2 ± 0.2	1 ± 0.1
Initial Measuring Length	25 ± 0.5	20 ± 0.5	20 ± 0.5	10 ± 0.5	10 ± 0.5

Tab.1: Dimensions of the ISO 37 dumbbell bars¹²

The test rods in DIN 53504 are almost identical to those in ISO 37 except for minimal differences. However, there are different descriptions of the test rods:

ISO 37	DIN 53504	Deviations (Except Tolerance Ranges):
Type 1	S1	
Type 1A	S1A	Outer transition half radius: ISO 37(25mm), DIN 53504 (20mm) Initial measuring length: ISO 37(20mm), DIN 53504 (25mm)
Type 2	S2	
Type 3	S3A	
Type 4	S3	

Table 2: Comparison of the different designations of the corresponding shoulder bars in ISO 37 and DIN 53504 with indication of significant differences in dimensions

¹¹ ISO 37 (issue 12-2011), P.7

¹² The data have been taken from ISO 37 (edition 12-2011), p.5f.

ISO 37 also permits two different rings with a rectangular cross-section for tensile testing. DIN 53504 also prescribes two rings, but both standards have only one standard ring in common, as the following table shows:

Dimensions [mm]	Ring		
	Not Standardized	Type A	Type B
ISO 37	Not Standardized	Type A	Type B
DIN 53504	R1	R2	not standardized
Outer Diameter d_3	52.6	44.6	10
Inside Diameter d_4	44.6	36.6	8
Width b	4	4	1
Thickness a	4 (or 6.3 in DIN)	4 (or 6.3 in DIN)	1

Tab. 3: Standardized rectangular rings for tensile testing (see **Fig. 2** for an explanation of the indices)

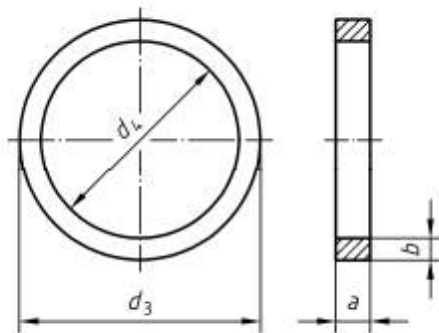

Fig. 2: Representation of a standardized rectangular ring from DIN 53504¹³

The explanation of the calculation of the initial gauge length and the mean circumference for the stress value would be too much at this point. Reference is made here to the notes in the two standards.

The production of test specimens requires a high degree of care and experience. Scoring and notching during classical punching can lead to a significant deterioration of the results. This is discussed in more detail in sub-section 5.1.

DIN 53504 also provides information on the testing of O-rings. ASTM International even has its own standard (ASTM D1414), which only deals with the testing of O-rings. A separate article under the heading, "Tensile test" deals with the special features of tensile tests on O-rings.

¹³ Picture used from DIN 53504 (Edition 10-2009), p.8

3.2 Meaning and Differences of Dumbbell Bars vs. Standard Rings

While in the 1960s the ring - introduced many decades earlier by MARTENS¹⁴ at the State Materials Testing Office in Berlin - became established as the most widely used test specimen¹⁵. Today, it has largely been replaced by the dumbbell bar. The ring had the advantage that continuous scanning of the change in length of the strain area was no longer necessary. This scanning is no longer a problem with today's testing machines and their long-stroke extensometers. Occasionally, the rings are still used in compound production for batch release in batch production. However, the dumbbell bar has become completely accepted for compound releases for the following reasons:

- At present, classic punching tools are increasingly being replaced by punching knives (see sub-section 5.1 Preparation of Test Specimens). In test laboratories, which still work with classic punching tools, the large negative influence of a possible non-ideal cutting edge on the test results is less with a 2 mm thick shoulder bar than with a 4 mm thick rectangular ring.
- Due to the larger cross-section to be torn, rings usually provide worse values than test rods. This effect is explained in more detail in sub-section 5.4 Influence of the Specimen Cross-Section / Volume.
- Dumbbell bars can be used to examine the influence of the rolling direction¹⁶ of the test plate by punching half of the test bars to be examined out of the test plate at a 90° angle. That is because the properties of a test plate are usually not ideally isotropic. This effect becomes particularly clear with the test of the tear resistance.
- Fewer test plates are required as their surface can be used more efficiently with dumbbell bars than with rings.

3.3 Test Speeds

As test speed (actually speed of strain) in ISO 37

- 200 mm/min (for bar test specimens type 3 and 4 and small ring type B), and
 - 500 mm/min (for Type 1, 1A and 2 rod test specimens and Type A large ring)
- are required.

DIN 53504 requires a feed rate of 200 mm/min for the dumbbell bars S2, S3 and S3A and a feed rate of 500 mm/min for the larger bars S1 and S1A. The two rings R1 and R2 should be tested at 500 mm/min.

¹⁴ Adolf Martens (1850-1914) was at the end of the 19th century one of the most important and outstanding materials researchers and examiners in the German Empire. He was particularly outstanding in the field of materials testing of metals. His name was immortalized in the name of an iron-carbon structure, namely "martensite". For many years he was head of the Royal Materials Testing Office in Dahlem near Berlin. Source of information: http://www.amf.bam.de/de/adolf_martens/index.htm (access to website on: 11.04.2014)

¹⁵ vgl. ECKER, R.: Mechanische-technologische Prüfung von Kautschuk und Gummi in: BOSTRÖM, S. (Hrsg.): Kautschuk-Handbuch, Band 5, Stuttgart, 1962, S. 102

¹⁶ vgl. BROWN, Roger: Physical Testing of Rubber, New York, 42006, S. 134

3.4. Useful Information from ASTM D412

In the related test standard ASTM D 412 ("Standard Test Methods for Vulcanized Rubber and Thermoplastic Elastomers - Tension"), there are six standard test rods. Their dimensions differ from those in ISO 37. In addition, there are four different test rings, two of which correspond to the dimensions of the ISO 37 rings. The most frequently required test speed is 500 mm/min. In many other respects there is a high technical comparability to ISO 37.

3.5 Important Parameters¹⁷ from the Tensile Test and Their Significance for Practical Application

The **tensile strength at break** σ_R is the force at the moment of tearing F_R of the specimen, relative to the initial cross section A_0 . It is given in N/mm² or MPa with the following ratio: 1N/mm² = 1 MPa.

A related material parameter is the **tensile strength** σ_{max} . This is the quotient of the maximum force F_{max} and the initial cross section A_0 . For most elastomers, however, the maximum force is the same as the force at the moment of tearing.

It should be noted that the terms tensile strength at break and tensile strength are often used synonymously because "in the case of elastomers (...) the force F_R occurring during tearing is generally also the maximum force F_{max} when the tensile test is carried out at room temperature or at temperatures above room temperature".¹⁸ This mistaken equation of the two characteristic values can lead to problems if F_R and F_{max} are not identical.

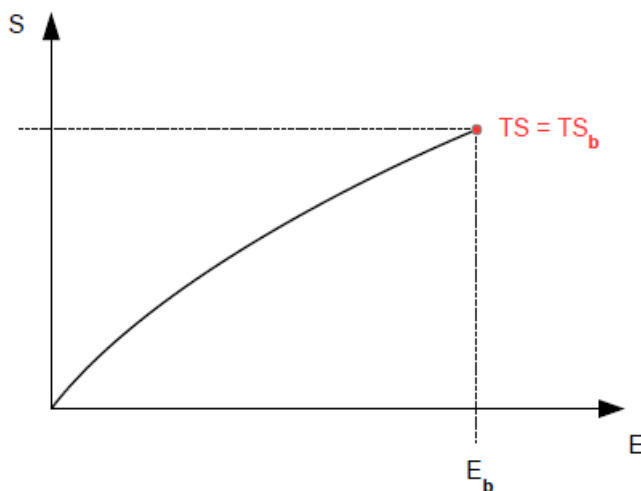

Fig. 3: Classical tensile elongation curve of an elastomer: The maximum force F_{max} (=TS) is equal to the force F_R (TS_b) occurring during tearing.¹⁹

¹⁷ The terms and abbreviations are taken from DIN 53504, p.5f.

¹⁸ Translated from DIN 53504 (Ausgabe 10-2009), S.6

¹⁹ The diagram is based on ISO 37 (edition 12-2011), p.3. The designations and abbreviations of ISO 37 were retained for standardization purposes.

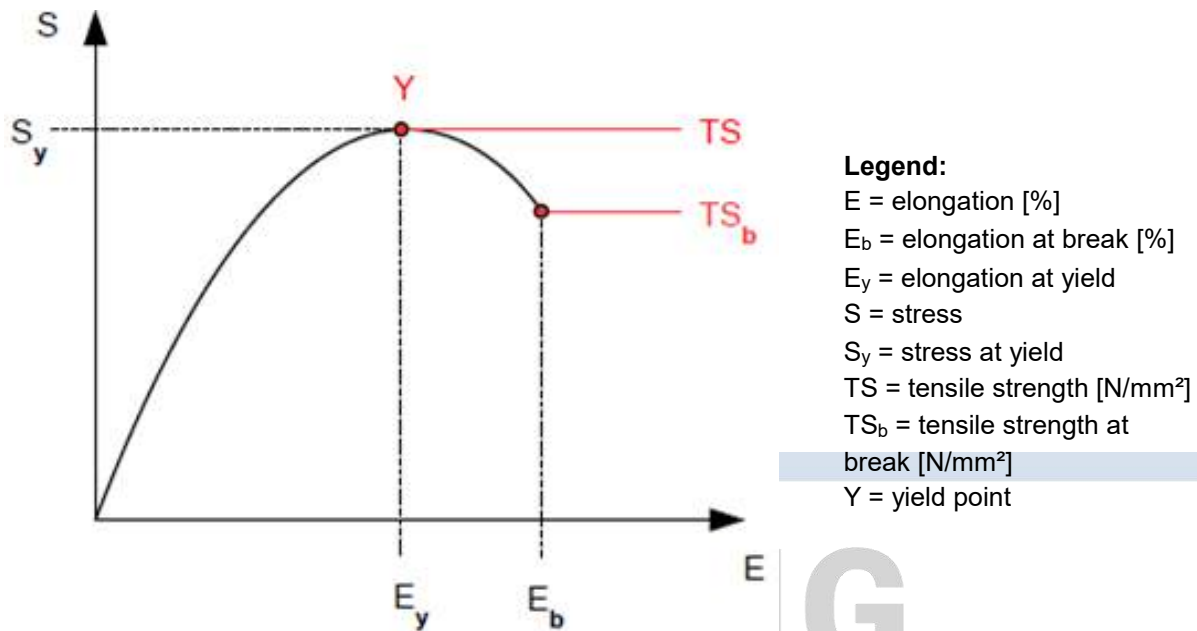

Fig.4: Rare special case in the tensile testing of elastomers: The maximum force F_{\max} (=TS) differs from the force F_{\max} (TS_b) occurring during tearing. There is a maximum (=Y) which is reached significantly before the tear.²⁰

The following table provides an overview and classification of the usual strength ranges of elastomers:

Tensile Strength Range	Classification
0 to 5 N/mm ²	Elastomer with low strength
5 to 10 N/mm ²	Elastomer of medium strength
10 to 15 N/mm ²	Elastomer with high strength
Larger than 15 N/mm ²	Elastomer with very high strength

Tab. 4: Tensile strength ranges of elastomers

Before the tensile test, a specific measuring length or initial length L_0 is determined. In order to obtain the **elongation at break ϵ_R** , the difference between the total length L_R at the moment of breaking and the measured or initial length L_0 is calculated. This difference is then divided by the measuring length or initial length L_0 . Since the elongation at break is usually expressed as a percentage, the result must be multiplied by 100.

With elastomers, the elongation during the tensile test results in an extreme reduction of the original cross-section. If the stress were calculated with the cross-section at the moment of tearing, the result would sometimes be up to ten times as large²¹. This has to do with the fact that due to the high elongation and crystallization effects the strength increases temporarily.

²⁰ Ebd., S.3

²¹ vgl. HOUWINK, R.: Grundriss der Technologie der synthetischen Hochmolekularen, Leipzig, 1952, S. 85

The technical literature also presents approximate formulas for calculating the true tensile strength at break. SPÄTH derives such a formula on the assumption of "uniform elongation over the entire test length and a constant test volume"²²:

$$A \cdot L_0 = A' \cdot L_R$$

A = Initial cross section of the test specimen in the area to be torn

A' = Cross section at the moment of tearing

L₀ = Initial length of the measuring section

L_R = Total length at the moment of tearing (L_R = L₀ + ΔL)

ΔL = Increase in length L during tearing

$$A' = A \cdot (1/(1+\epsilon))$$

$\epsilon = ((L_R - L_0) / L_0) = \Delta L / L_0 =$ relative elongation

$L_0 / L_R = (1/(1+\epsilon))$

$$\sigma_w = F/A' = (F/A) \cdot (1 + \epsilon) = \sigma_R \cdot (1 + \epsilon)$$

F = force at the moment of tearing

σ_w = "true" tensile strength at break

σ_R = measured tensile strength at break

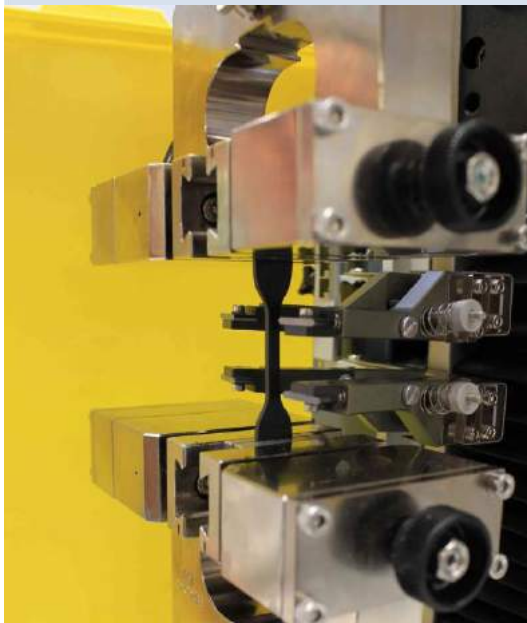

Fig. 5: Tensile test rod clamped in a tensile testing machine before the start of loading. The extensometers do not yet touch the measuring area²³ between the shoulders.

²² SPÄTH, Wilhelm: Beiträge zur Technologie der Hochpolymeren: Gummi und Kunststoffe, A.W. Gentner Verlag, Stuttgart, 1956, S.109f.

²³ The initial gauge length is standardized (see Table1) and is always slightly shorter than the length of bar C



Fig. 6: Stretched dumbbell rod, shortly before tearing. The extensometers now rest against the dumbbell rod and measure its elongation in the standardized measuring range. Here you can see how the cross-section of the measuring range narrows due to the elongation.



Fig.7: The torn dumbbell rod is removed from the clamping jaws. This is the end of the tensile test.

(see Fig.1).

O-Ring Prüflabor Richter GmbH
Kleinbottwarer Str. 1
71723 Großbottwar

Telefon 07148 / 16602-0
Fax 07148 / 16602-299
info@o-ring-prueflabor.de
www.o-ring-prueflabor.de

Geschäftsführer:
Dipl.-Ing. Bernhard Richter
Ust-ID-Nr. DE 277600966
Steuer-Nr. 71342/02407 FA LB

Sitz der Gesellschaft:
Großbottwar
Amtsgericht Stuttgart
HRB 737482

Volksbank Ludwigsburg
IBAN DE96 6049 0150 0820 5810 03
SWIFT GENODE31LBG

In the tensile testing of metals, there is a relatively large and pronounced range in which the Hooke's law applies, meaning that there is a direct proportionality between stress and strain. The application limits of metals are usually within this range. The designer therefore can use precise moduli of elasticity.

With elastomers, on the other hand, there is only a very small area in which Hook's law applies. Rubber materials are almost always used in a range for which no single modulus of elasticity can be specified. ECKER refers here to the "differential modulus of elasticity E' ". In tensile tests, it is often common to specify the stress values at, e.g. 100% or 200% elongation. According to DIN 53504, the "**Stress value σ_i** is the quotient of the tensile force F_i present when a certain elongation is reached and the initial cross-section A_0 ." ²⁴

Sometimes the earlier common term "module value" (e.g. M100 for the stress value at 100% elongation) can still be found. For the reasons given above, however, this is factually incorrect and should therefore be avoided.

4. Technical Requirements for Tensile Testing Machines and Their Software for Testing Elastomers

While it was still difficult in the 1960s to obtain tensile testing machines with a deformation speed that could be varied in the range of powers of ten, which had a relatively inertia-free force and travel display²⁵ and which enabled simple and accurate evaluation of the results, it is no longer a problem today.

The following special equipment is helpful when testing elastomers:

When testing elastomers, **high travels** at relatively low forces (<500N) are often to be expected, as some materials have elongations at break of 700% or more. Therefore, tensile testing machines with long traverses are required and the extensometers must also be able to travel the long distances. Maximum measuring ranges up to 750mm are sufficient in our daily testing routine.

The **extensometers** must be so robust that they will not be damaged by a possible knockback when the specimen tears. On the other hand, they must only be applied to the specimen with a such low force that sensitive specimens do not tear at the contact point. In addition, the linear guide should work as frictionless as possible, since generally low forces are used when testing elastomers.²⁶ The resolutions ($3\mu\text{m}$ ²⁷ or better) and accuracies (0.1mm or better) currently available are sufficient for testing in the elastomer range.

²⁴ DIN 53504 (Edition 10-2009), p.6

²⁵ vgl. ECKER, R.: Mechanische-technologische Prüfung von Kautschuk und Gummi in: BOSTRÖM, S. (Hrsg.): Kautschuk-Handbuch, Band 5, Stuttgart, 1962, S. 102

²⁶ vgl. KÖNIG, Klaus: Präzision unter Spannung in KGK, 05/2013, Artikel abgerufen am 19.06.2014: <http://www.kgk-rubberpoint.de/texte/anzeigen/4344/Praezision-unter-Spannung>

²⁷ vgl. www.en.wikipedia.org/wiki/Extensometer (Zugriff auf Webseite am 04.08.2014)

It is also possible to measure the change in length with the help of a laser or a video recording. For this method, marking points must be attached to the test rods, which can sometimes lead to problems (e.g. with test rods stored in oil or certain materials). If a laser is used, the laser beam may be deflected by the pane of the temperature chamber during tests in temperature chambers. This problem does not occur with the more modern video systems, which film the strain, process it with a computer and evaluate it.²⁸

In addition, R&D facilities sometimes require the initial stiffnesses, meaning initial pitches, of a material. Since these are relatively small strain ranges, the 1/10mm accuracy mentioned above is not sufficient. However, there are also technical solutions for these rare exceptions.

Special attention must also be paid to the selection of the specimen grips or clamping jaws. Due to the high deformability of elastomers, the specimen shrinks during the tensile test. This creates the danger that the specimen slips out of the clamping jaw. This problem is usually solved by the use of **self-clamping fixtures**. This type of grips, which are also called "**wedge grips**" by a well-known tensile testing machine manufacturer, have the following advantages:

- They "are very well suited for shrinking specimens as they automatically retighten and thereby compensate the decreasing specimen thickness.
- The wedge grips are symmetrically closing. This automatically positions the specimen in the tensile axis and no thickness adjustment is required.
- Due to the large clamping length and good jaw guidance properties, the surface pressure on the specimen can be kept low.
- Due to their high temperature resistance and low overall height, they are very well suited for use in temperature chambers"²⁹

As an alternative, there are also **pneumatically operated clamping jaws (pneumatic specimen grips)**. They are suitable for clamp-sensitive materials, and the combination with foot-switches makes operation much easier as the laboratory technician now has both hands free during the clamping process. This type of clamping tool has the following advantages:

- "The separation of tensile force and closing force ensures a constant clamping force during the entire test sequence.
- The contact pressure on the sample is reproducible [and controllable via the air pressure].
- A (...) constant force system protects the specimen from unwanted forces during the clamping process.
- Clamping-sensitive specimens can be held securely by adjusting the pneumatic pressure and clamping breaks can be avoided."³⁰

The surface of the clamping jaws or clamping jaw inserts is also important. It must have a structure in which the shrinking elastomer specimen can get caught without causing

²⁸ vgl. BROWN, Roger: Physical Testing of Rubber, New York, ⁴2006, S. 144f.

²⁹ Translated from <http://www.zwick.de/de/produkte/probenhalter-pruefwerkzeuge/keil-spannwerkzeuge.html> (Zugriff auf Webseite am 19.06.2014)

³⁰ <http://www.zwick.de/de/produkte/probenhalter-pruefwerkzeuge/pneumatik-probenhalter-und-steuereinheiten.html> (Zugriff auf Webseite am 19.06.2014)

predetermined breaking points or cracks due to sharp edges. In some cases, elastomer-coated clamping jaw inserts are also used.

Most tensile tests are performed at room temperature (23°C), but a temperature chamber can be used to determine strength values at elevated or low temperatures. Interestingly, here is the percentage drop or increase of the strength/elongation values due to the temperature difference. These findings can be particularly important for seals that are subjected to high temperatures and tensile stress during use. In most cases, the temperature chamber can be approached from behind the tensile testing machine and can enclose the clamping jaws and extensometers together with the specimen. Heating is usually carried out with an electric heater, cooling with liquid nitrogen. For elastomers, a test range of -60°C to 250°C is sufficient. In our daily testing practice, however, the use of a temperature chamber is irrelevant, even if this would sometimes make sense from an application technology point of view.

After all, good **software for evaluating** the test results is important. In addition to intuitive and largely self-explanatory operation, special attention must also be paid to interfaces for transferring and converting the data into generally used formats. Due to today's possibilities of EDP, many data sets are created even with simpler tensile tests, which are only of use if they can be saved and retrieved easily and for the most part can be read out at least in their basic data without special software.

The special features of the **tensile test of O-rings**, including the special accessories required, are dealt with in a separate technical article.

5. Useful Information for the Interpretation and Evaluation of Test Results from the Tensile Test

The tensile test can be used, among other aspects, to determine the optimum degree of cross-linking of a material. On the other hand, it is also important to know which external influencing factors can significantly change or even falsify test results from the tensile test. Only with this background knowledge is it possible to test accurately and reproducibly and to interpret the results sensibly for practical use.

5.1 Influences of Tensile Strength or Degree of Cross-Linking on Material Properties

Similar to the compression set, the tensile strength is also an indirect measure of the cross-linking density of a material. The cross-linking density has an important influence on various important properties of a seal. There is no specific cross-linking density at which all properties achieve an optimum, but a compromise must be found for the respective application. This can be seen from the following graph³¹ (**Fig. 8**):

³¹ This diagram was created and revised with the help of the following template from the technical literature: MATSCHINSKI, Paul (Hrsg.): Roh- und Hilfsstoffe in der Gummiindustrie, VEB Deutscher Verlag für Grundstoffindustrie, Leipzig, 1968, S. 171

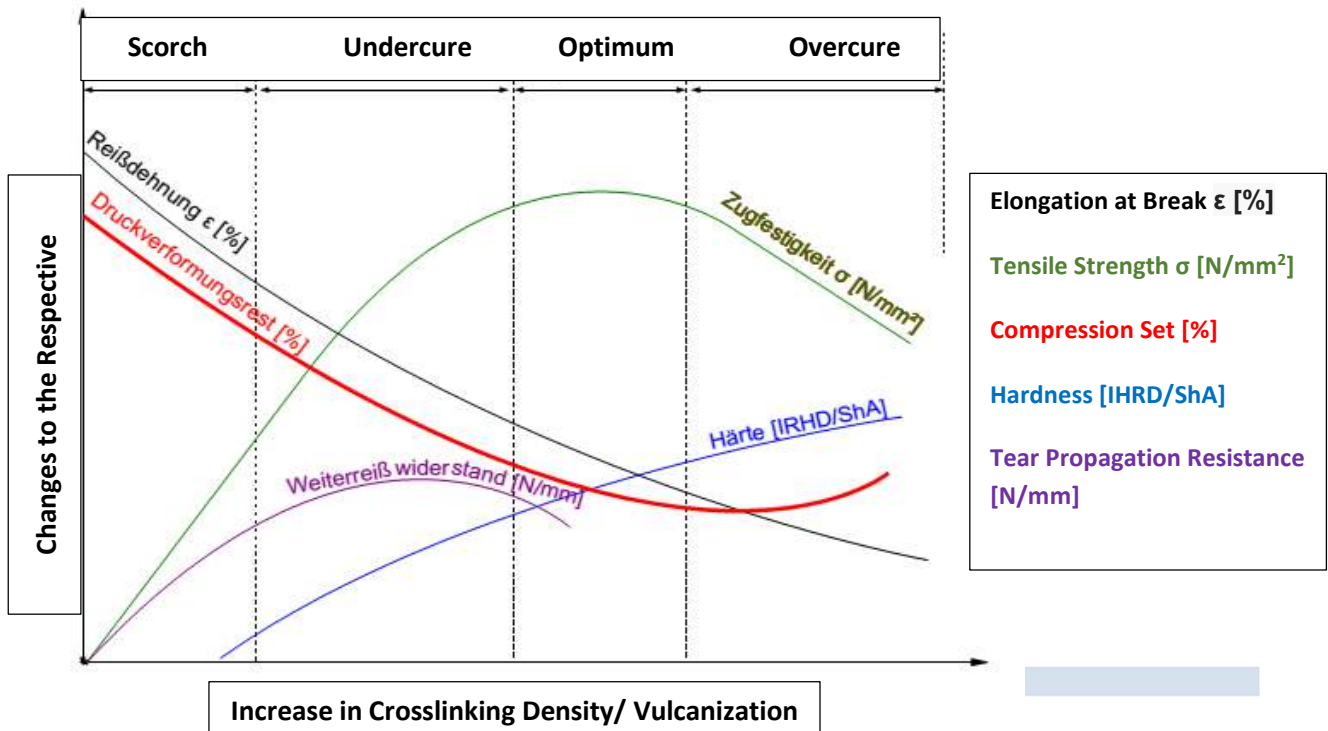

Fig. 8: The tensile strength reaches its best value at the optimum cross-linking density, while no conclusion can be made about the ideal network density from the elongation at break.

5.2 Influences on Tensile Test Results

The following influencing factors are sorted according to their importance in descending order. This classification is based on the daily work in our test laboratory, but in individual cases each of the mentioned influences can become of great and decisive importance.

5.2.1 Influence of Sample Preparation and Sample Pretreatment

Test rods are punched out of 2mm thick test plates. During punching, the test plate is pressed together before and during shearing, resulting in a concave geometry after relaxation. This effect is particularly pronounced with blunt punching tools. If you now look at such a test rod in cross-section, you can see that a tip has formed at the beginning or end of the concave cutting edge. At this point, premature tearing usually occurs, which in our experience can worsen the test results up to 10%.



Fig.9: Typical punching tool: The tool has a spring activated ejector for the dumbbell rods.

Recently, punching knives have also been offered. These tools have thin interchangeable blades, similar to a carpet knife. Due to the thin blade cross section, hardly any material is displaced. The punching knives "can be changed without any problems, so there are no downtimes and regrinding costs. Each punching knife has [also] an integrated ejector."³² The result is a test rod with an exact rectangular cross-section.



Fig. 10: Punching knife: The screws on the punching knife are necessary for changing the blades. The tool also has a spring activated ejector for the dumbbell rods.

We speak of punched test bars if they were produced with a classic punching tool and of cut test bars if they were produced with a punching knife. "Cut" here does not mean a pulling cut, as is done with a knife in the case of food, for example, nor is it a cutting with a circular rotating blade, but rather a "punched cutting".

³² Translated from <http://www.hess-mbv.de/kcfinder/upload/files/Dumbbell%20Messer.pdf> (Zugriff auf Webseite am 28.05.2014)

Classic punching tools (**Fig. 9**) are only still used in our daily laboratory routine for very hard materials.

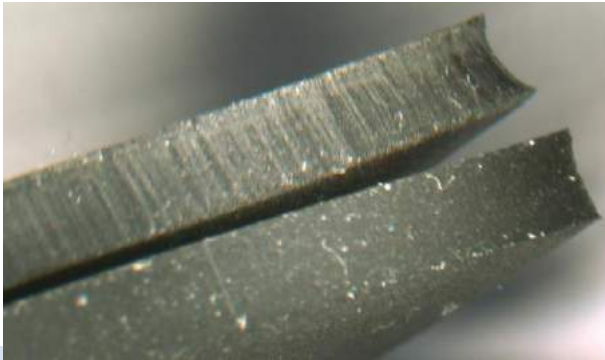

Fig. 11: Comparison of the cut surfaces on an S2 bar: The upper dumbbell bar was punched with a classic punching tool, the lower with a punching knife.

Internal tests on various EPDMs and a TPE showed that test rods produced with a punching knife had higher strength and elongation at break values, as the following table shows:

		Tensile Strength [N/mm ²]	Elongation at Break [%]
EPDM 1 Classic Punching Tool	Mean	5.31	330
	Median	5.38	323
	s	1.21	97
EPDM 1 Punching Knife	Mean	5.75	379
	Median	5.89	403
	s	0.35	42
EPDM 2 Classic Punching Tool	Mean	9.85	439
	Median	10.42	489
	s	1.45	128
EPDM 2 Punching Knife	Mean	11.57	493
	Median	11.82	524
	s	0.96	54
TPE (TPC-ET) Classic Punching Tool	Mean	5.78	527
	Median	5.98	552
	s	0.72	71
TPE (TPC-ET) Punching Knife	Mean	6.2	537
	Median	6.06	527
	s	0.7	54

Table 5: Influence of the punching method on tensile strength and elongation at break. The investigations were carried out on five S2 rods per material. (s = standard deviation)

5.2.2 Influence of Increased Temperature

At a certain deformation speed a strong internal heating takes place in the specimen. This is referred to as the "Gough-Joule effect" in technical literature.³³ Most tensile tests are thermodynamically adiabatic and non-isothermal processes, since the heat generated cannot be dissipated quickly enough due to the poor thermal conductivity of elastomers.³⁴

However, the following section will not deal with these effects, but with the heating of the specimen, the extensometers and the clamping jaws before the actual tensile test with the aid of a temperature chamber.

In general, the tensile strength and elongation at break of elastomers decrease with increasing temperature. At high temperatures, the physical load limits of an elastomeric material decrease, which is why such tests are not only interesting due to aging effects, but also provide indications of the real load limits of a material in real use, which usually takes place at elevated temperatures. In the case of compounds with a high filler content, the temperature influence is lower.

Depending on the elastomer base, there are compounds whose strength decreases significantly more in heat than with other compounds. As described above, the strength requirements in most applications are far from reaching the actual strength limits of the compounds. However, most cracks begin at flaws, so that much lower forces or deformations are sufficient to trigger a seal failure. By testing at elevated temperatures, it is now easier to estimate how much this risk increases as the temperature rises.

The following Table 6 gives an overview of how tensile strength and elongation at break change with increasing hardness and temperature³⁵. The sharp drop in both properties begins at only slightly higher temperatures, far below the real operating temperatures.

	Test Temperature	FKM 55 ShA	FKM 60 ShA	FKM 75 ShA
Tensile Strength [N/mm²]	23°C	8.5	11.1	10.4
	70°C	3.0	4.6	5.4
	120°C	2.1	2.6	3.7
	150°C	1.8	2.2	3.3
Elongation at Break [%]	23°C	282	236	231
	70°C	170	143	140
	120°C	116	99	84
	150°C	90	81	72

Tab. 6: Influence of temperature and different hardnesses on tensile strength and

³³ When the stretched sample is relaxed, cooling takes place.

There is also a phenomenon with the Gough Joule Effect that a loaded rubber sample contracts when heated.

³⁴ vgl. ECKER, R.: Mechanische-technologiesche Prüfung von Kautschuk und Gummi in: BOSTRÖM, S (Hrsg.): Kautschuk-Handbuch, Band 5, Stuttgart, 1962, S. 114

³⁵ The results come from tests carried out by Freudenberg Forschungsdienste (FFD), Weinheim on behalf of O-Ring Prüflabor Richter GmbH.

elongation at break of bisphenolic cross-linked FKM compounds.

5.2.3 Influence of Changed Deformation Rate

In ISO 37, the test speed - as already described above - is fixed at 200 and 500 mm/min. According to BROWN, a deviation of $\pm 10\%$ from the test speeds required by the standards generally has a negligible effect on tensile strength. However, it is possible that for TPE combined with low temperatures there may be a higher sensitivity to changes in deformation speed.³⁶

In some applications, however, much higher loads occur in reality. The example of bungee jumping makes this clear: At a drop height of 12m, a speed of approx. 70 km/h is reached after 2 seconds flight time, this corresponds to 19.4m/s, with which the rope consisting of approx. 880-1400 latex monofilaments is loaded.³⁷ The test speeds in ISO 37 are only 0.0033 m/s (= 200mm/min) and 0.0083 m/s (= 500mm/min) respectively.

An important study on the influence of deformation speed was carried out by FROMANDI and staff.³⁸ A test device was used which allowed deformation rates of up to 20m/s. Compounds with the following basic elastomers were investigated: NR, SBR, NBR, IIR and VMQ.

Generally, the stress value σ_{300} , meaning the stress at 300% elongation, increased with increasing deformation speed for almost all elastomers (except CR).

The elongation at break increased with increasing deformation speed, except for elastomers, which tend to crystallize at certain deformations (e.g. natural rubber and polychlorobutadiene). They reached a minimum at approx. 10,000% deformation / second, only to rise again afterwards.

The tensile strength at break decreased slightly with increasing speed in most cases, except for VMQ, which showed constant values.

³⁶ vgl. BROWN, Roger: Physical Testing of Rubber, New York, 42006, S. 140

³⁷ vgl. <http://www.bungeesports.de/springer/faq1.htm> (abgerufen am 27.06.2014)

³⁸ vgl. ECKER, R.: Mechanische-technologische Prüfung von Kautschuk und Gummi in: BOSTRÖM, S (Hrsg.): Kautschuk-Handbuch, Band 5, Stuttgart, 1962, S. 115 ff.

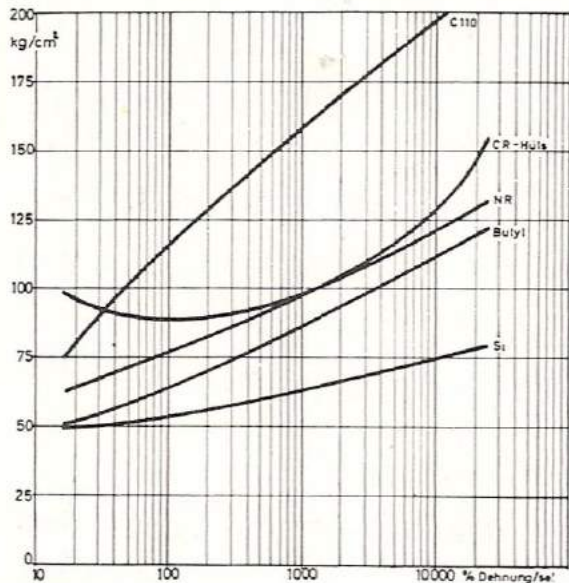

Fig. 12: Stress values at 300% strain as a function of deformation speed: The strain is plotted logarithmically in percent/second on the abscissa³⁹. Materials investigated (from top to bottom): C110 = NBR Perbunan C110, CR Hüls = Buna Hüls 150, NR, Butyl = IIR, Si = Siloprene

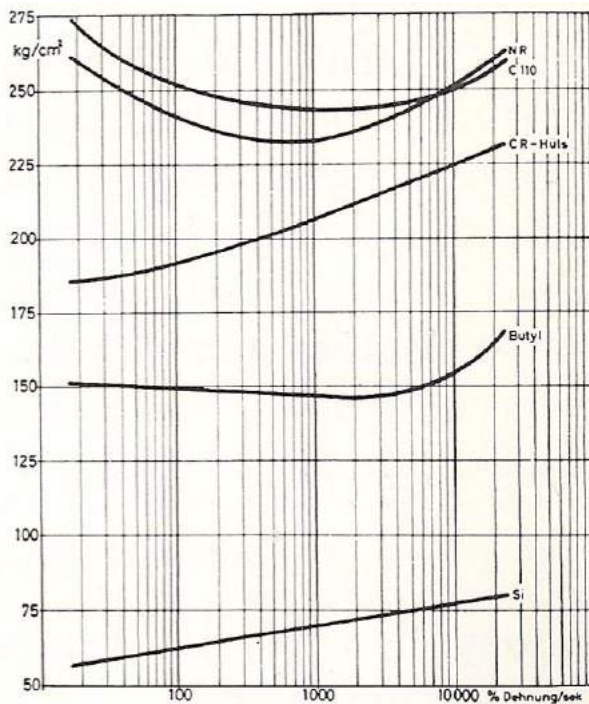

Fig. 13: tensile strength at break as a function of deformation speed: The elongation is plotted logarithmically in percent/second on the abscissa⁴⁰. Materials investigated (from top to bottom): NR, C110 = NBR Perbunan C110, CR Hüls = Buna Hüls 150, Butyl = IIR, Si = Siloprene

³⁹ The diagram was taken from: ECKER, R.: Mechanische-technologische Prüfung von Kautschuk und Gummi in: BOSTRÖM, S (Hrsg.): Kautschuk-Handbuch, Band 5, Stuttgart, 1962, S. 117

Note for converting the old unit: $10\text{kg/cm}^2 = 0,981\text{N/mm}^2 \approx 1\text{N/mm}^2$

⁴⁰ The diagram was taken from: ECKER, R.: Mechanische-technologische Prüfung von Kautschuk und Gummi in: BOSTRÖM, S (Hrsg.): Kautschuk-Handbuch, Band 5, Stuttgart, 1962, S. 117

Note for converting the old unit: $10\text{kg/cm}^2 = 0,981\text{N/mm}^2 \approx 1\text{N/mm}^2$

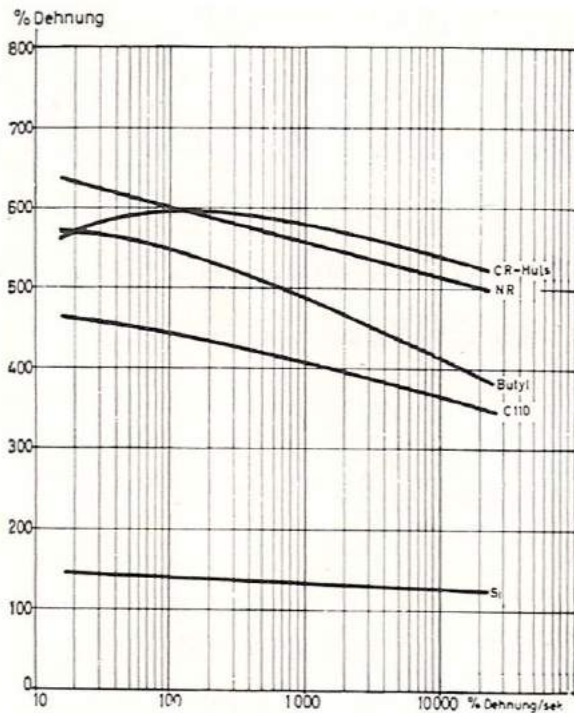

Fig. 14: Elongation at break as a function of deformation speed: The elongation is plotted logarithmically in percent/second on the abscissa⁴¹. Materials investigated (from top to bottom): NR, C110 = NBR Perbunan C110, CR Hüls = Buna Hüls 150, Butyl = IIR, Si = Siloprene

Of course, the question of the practical relevance of these properties must be asked here. And such stresses certainly do not arise in the case of seals. However, in the case of high-frequency damping, this can be of significance.

5.2.4 Influence of the Specimen Cross Section / Volume

As early as 1948, HIGUCHI⁴² and its employees carried out tensile tests on various elastomer compounds (NR, SBR, etc.) in order to gain knowledge about the influence of different specimen volumes on a constant mixture. They determined two mixture-dependent constants, so that the dependence of the tensile strength on the volume can be represented as follows.⁴³:

$$\sigma_{\max} = a - b \cdot \ln V$$

σ_{\max} = tensile strength

a und b = material-dependent constants

V = specimen volume

Interestingly, specimen volumes have little influence on stress values (previously incorrectly

⁴¹ The diagram was taken from: ECKER, R.: Mechanische-technologische Prüfung von Kautschuk und Gummi in: BOSTRÖM, S (Hrsg.): Kautschuk-Handbuch, Band 5, Stuttgart, 1962, S. 117
Note for converting the old unit: $10\text{kg/cm}^2 = 0,981\text{N/mm}^2 \approx 1\text{N/mm}^2$

⁴² HIGUCHI, Takeru; LEEPER, H.M.; DAVIS, D.S.: Determination of Tensile Strength of Natural Rubber and GR-S Effect of Specimen Size in: Analytical Chemistry; 20.Jahrgang, Nr.11, 1948, S.1029-1033

⁴³ vgl. ECKER, R.: Mechanische-technologische Prüfung von Kautschuk und Gummi in: BOSTRÖM, S (Hrsg.): Kautschuk-Handbuch, Band 5, Stuttgart, Verlag Berliner Union, 1962, S. 119

referred to as modulus values) and elongation at break.⁴⁴

NAGDI describes the influence of specimen geometry on tensile strength as follows and gives indications of the causes of this behavior:

"Generally, the following rule applies: the larger the initial cross section or the larger the volume of the specimen, the lower the tensile strength. This dependence can be explained by the number of flaws in the specimen. The smaller the volume of the specimen, the less likely it is that defects will be present".⁴⁵ Even in the most carefully produced elastomer compounds, there will be such "flaws" or inhomogeneities. "The sum of all such inhomogeneities, such as defects in the regular structure, foreign inclusions, filler agglomerates, vacuoles, cracks, is called the microstructure of the material. Each inhomogeneity causes a strong local stress concentration in its immediate environment during deformation processes. The "most dangerous" inhomogeneity then becomes the starting point of the fracture."⁴⁶ This explains why the real strength of elastomer compounds is often two to three orders of magnitude below the molecular strength.⁴⁷

In practice, this statement is confirmed that large volume test specimens have lower tensile strengths in tensile tests on O-rings of the same compound: O-rings with small cord thickness (e.g. 1.78 mm) have significantly better values than O-rings with large cord thickness (e.g. 6.99 mm).

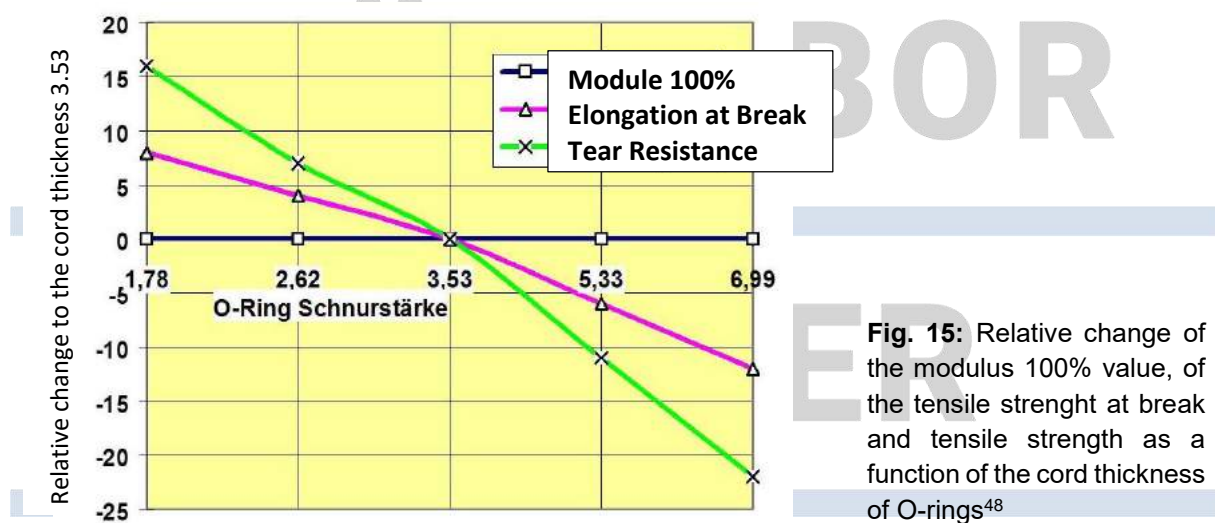

Fig. 15: Relative change of the modulus 100% value, of the tensile strength at break and tensile strength as a function of the cord thickness of O-rings⁴⁸

Iman NAZENI⁴⁹ of the Indonesian Rubber Research Institute (BPPK in Bogor) presented an

⁴⁴ HIGUCHI, Takeru; LEEPER, H.M.; DAVIS, D.S.: Determination of Tensile Strength of Natural Rubber and GR-S Effect of Specimen Size in: Analytical Chemistry; 20. Jahrgang, Nr. 11, 1948, S. 1030

⁴⁵ Translated from NAGDI, Khairi: Gummi-Werkstoffe Ein Ratgeber für Anwender, Ratingen, 2002, S. 290

⁴⁶ Translated from ECKER, R.: Mechanische-technologische Prüfung von Kautschuk und Gummi in: BOSTRÖM, S (Hrsg.): Kautschuk-Handbuch, Band 5, Stuttgart, Verlag Berliner Union, 1962, S. 120

⁴⁷ vgl. ECKER, R.: Mechanische-technologische Prüfung von Kautschuk und Gummi in: BOSTRÖM, S (Hrsg.): Kautschuk-Handbuch, Band 5, Stuttgart, Verlag Berliner Union, 1962, S. 119

⁴⁸ The data to create the diagram were taken from: Parker Hannifin, O-Ring Division: Effect of O-Ring Cross-Section and Rate of Pull on Physical Properties in: Technical Bulletin, ORT-021, 11/30/92

⁴⁹ NAZENI, Iman: Einfluss der Dicke der Prüfvulkanisate auf die Messwerte der Zerreifestigkeit beim Standard-Prüfverfahren nach ASTM, vorgestellt auf der Vortragstagung der Deutschen Kautschuk-Gesellschaft, Berlin,

interesting study on the influence of the thickness of the test rods on the tensile test result at a lecture conference of the German Rubber Society in Berlin in 1960:

He started from the assumption that the same fur from the roller is used for test plates of different thicknesses. During the further processing of this fur and the production of thin test plates it is compressed more at certain places. Due to the higher pressure, microcracks from the manufacturing process can most probably be sealed by the roller. The distribution of the cracks is then presumably no longer statistically irregular, but dependent on the thickness of the test specimens. This is shown by the higher strength values of thin test rods compared to thicker ones.

In addition, he was able to prove that "an extension of the plasticizing time and the addition of plasticizers to the rubber (...) eliminates the thickness dependence of the elongation at break only in the case of unfilled compounds".⁵⁰ Furthermore, it could be shown that "the vulcanization duration (...) does not influence the dependence of the tensile strength on the thickness of the specimen".⁵¹

"By using a special mold in which the vulcanization pressure was directly applied to the compound, the dependence of the elongation at break on the thickness of the test specimens could be eliminated by additionally standardizing the vulcanization pressure".⁵²

5.2.5 Influence of the Compound Composition

Especially when formulations with mineral, hydrophilic fillers are used, it is known that they show a significant decrease in strength already after a short storage time (a few days) at room temperature due to humidity. This can be reversed by drying the samples (e.g. 4h/150°C), which is therefore required in some test specifications. However, these materials are usually used later under normal climatic conditions, which is why the significance of such regulations can certainly be questioned. At this point it should only be pointed out that especially on colored compounds considerable differences in results can be explained, depending on how much time has elapsed after vulcanization or after the last drying of the sample.

5.2.6 Testing after Pre-Load: Mullins Effect

Usually, almost all tensile tests are carried out on unloaded test specimens that have aged to a maximum in advance, but in practice a seal is no longer considered to be unloaded shortly after its initial use. And as a pre-loaded seal, it spends most of its service life.

The preloading of elastomers can have an influence on various material parameters, such as the buckling of an elastomer sample, which can lead to temporary local softening of the sample.

In our case of the tensile test, it is about the influence of strain of the material before the actual tensile test, meaning a preload of the material. If an elastomer specimen of a filled compound is pre-stretched, the stiffness decreases during the subsequent tensile test. This phenomenon was first discovered in 1903 by Bouasse and Carrière⁵³ and was extensively investigated and

1960 (Übersetzung: SCHOON, Th. G.F.)

⁵⁰ Translated from Ebd., S.10

⁵¹ Translated from Ebd., S.10

⁵² Translated from Ebd., S. 10 (Das Zitat wurde vom Präsens ins Präteritum gesetzt.)

⁵³ BÖL, M. Und REESE, S.: Simulation of filled polymer networks with reference to the Mullins effect in: AUSTRELL, P.-E. Und KARI, L.: Constitutive Models for Rubber IV, Taylor&Francis Group, London, 2005,

described by MULLINS⁵⁴ in 1947.

The so-called "Mullin Effect" can also occur in rubbers that tend to crystallize as a result of elongation. "Here, the crystallites behave like filler particles (self-reinforcement). The reversible conformational changes of the network allow a recovery from the stress softened state, which occurs only very slowly".⁵⁵

The following diagram⁵⁶ clearly shows this effect: The specimen, which was pre-stretched by 280% in advance, shows a less stiff material characteristic in the second tensile test than the unloaded specimen. The softening is increased by an even higher preload (420%). Another interesting effect is that the preloaded mixture merges approximately into the curve of the unloaded compound as soon as the degree of preload is exceeded (here 280% or 420%). The stiffness of the material can be determined by the gradient of the respective stress-strain curves. "The gradient of the 'softened' stress-strain curves for small strains is initially smaller, but then larger than the gradient of the unloaded curve. The stiffness of a body is given by the secant stiffness DF/Ds between two measuring points. Therefore, depending on whether one measures in the steep or flat area of the 'softened' stress-strain curve, there is a higher or lower stiffness compared to the unloaded curve (Mullin's paradox)."⁵⁷

If the elongation is repeated several times and the maximum elongation is not exceeded, the stress elongation curve stabilizes, and this effect is relatively constant.⁵⁸ So there is no continuous deterioration.

PRÜFLABOR

RICHTER

S.168

⁵⁴ MULLINS, L.: Effect of stretching on the properties of rubber in: Journal of Rubber Research 16, 1947, S.275-289

⁵⁵ Translated from FREUDENBERG Forschungsdienste SE&Co. KG (Hrsg.), ohne Autorengabe: MULLINS oder PAYNE? Zwei „starke Effekte der Gummielastizität“ in: FFD IM DIALOG, Ausgabe 2_2013, S.25 (Digital abgerufen am 09.07.2014: http://www.fnt-kg.de/pdf/FFDimDialog_2013_2.pdf)

⁵⁶ The diagram was taken from : ECKER, R.: Mechanische-technologische Prüfung von Kautschuk und Gummi in: BOSTRÖM, S (Hrsg.): Kautschuk-Handbuch , Band 5, Stuttgart, Verlag Berliner Union, 1962, S. 118

⁵⁷ FREUDENBERG Forschungsdienste SE&Co. KG (Hrsg.), ohne Autorengabe: MULLINS oder PAYNE? Zwei „starke Effekte der Gummielastizität“ in: FFD IM DIALOG, Ausgabe 2_2013, S.23f. (Digital abgerufen am 09.07.2014: http://www.fnt-kg.de/pdf/FFDimDialog_2013_2.pdf)

⁵⁸ vgl. PAIGE, Ryan E. und MARS, Will V.: Implications of the Mullins Effect on the Stiffness of a Pre-loaded Rubber Component vorgetragen bei: 2004 ABAQUS Users' Conference, S.2 (Webseite abgerufen am 09.07.2014: <http://www.axelproducts.com/downloads/PaigeMars.pdf>)

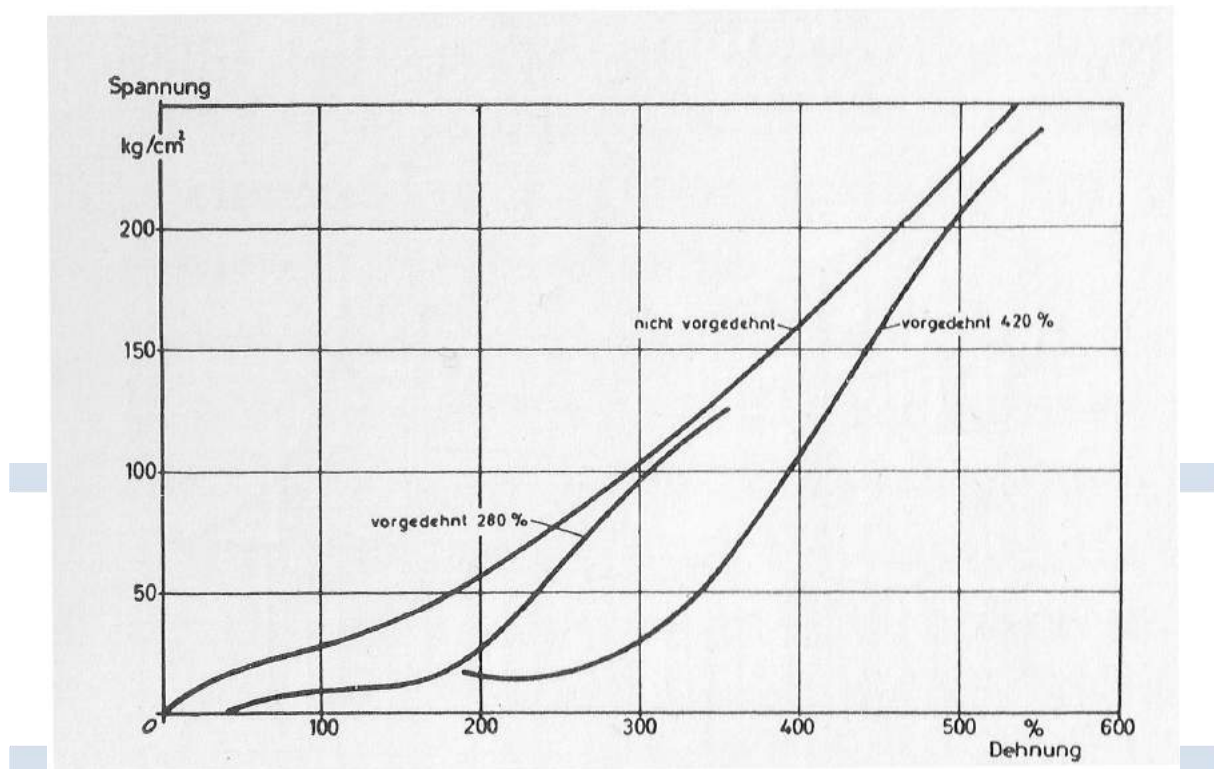

Fig. 16: Tensile yield curves of pre-stretched and non-pre-stretched specimens at the example of a tire tread compound made of natural rubber (Mullins effect)⁵⁹

The causes leading to the Mullins Effect can be both reversible and irreversible processes. The force applied in the tensile test induces the following changes in the polymer-filler and cross-linking structure of the elastomer compounds:

- "Tearing of short net arcs (irreversible)
- Breaking of mechanically unstable cross-linking connections (irreversible)
- Displacement of nodes of the network by short, strongly stretched net arcs, which do not tear
- Sliding of interlocks along the chain ends or between cross-linking points
- Diffusion of adsorbed polymer molecules along the carbon black surface
- Desorption of adsorbed chain sections from the filler surface and readsorption in a low-tension state
- Collapse of local agglomerates
- Displacement or orientation of filler particles in stretching direction"⁶⁰
- Decrease in material hardness

⁵⁹ Das Diagramm wurde entnommen von: ECKER, R.: Mechanische-technologische Prüfung von Kautschuk und Gummi in: BOSTRÖM, S (Hrsg.): Kautschuk-Handbuch, Band 5, Stuttgart, 1962, S. 118

⁶⁰ Translated from FREUDENBERG Forschungsdienste SE&Co. KG (Hrsg.), ohne Autorenangabe: MULLINS oder PAYNE? Zwei „starke Effekte der Gummielastizität“ in: FFD IM DIALOG, Ausgabe 2_2013, S.24 (Digital abgerufen am 09.07.2014: http://www.fnt-kg.de/pdf/FFDimDialog_2013_2.pdf)

DICK⁶¹ describes the phenomenon that often elastomer compounds reinforced by fillers, which have been pre-stretched and are then tested after a resting phase until they rupture, exhibit higher modulus values and tensile strengths than samples that have not been preloaded. Since stress-strain cycles frequently occur on components in practice, this property is sometimes advantageous.

In practice, knowledge of the Mullins Effect is particularly important in the design and construction of damping elements that are subject to constant preloading, such as engine mounts. The material characteristic of the elastomer component can be changed by the preload via the Mullins Effect.⁶²

When determining the spring stiffness of prefabricated components, it is recommended to run several load cycles in order to be able to measure reproducibly. This history must of course be noted in the test documentation.⁶³

5.2.7 Usual Accuracies for Tensile Tests

Towards the end of DIN 53504 there is a chapter dealing with the precision⁶⁴ of this process. In 1989, 17 laboratories took part in an interlaboratory test for tensile testing. The results for tensile strength, tensile strength at break and stress value 100% were compared and evaluated.

There aren't any conclusions about the materials investigated, instead they are merely divided into three strength levels.

It can be assumed that interlaboratory comparisons for a DIN standard meet the highest requirements, both with regard to the mixtures used (known formulations, ideal mixing and production conditions of the test plates, etc.) and the laboratory side (calibrated state-of-the-art test equipment, trained and experienced personnel).

It is, therefore, not possible to generally use the following results as a benchmark for the accuracy of tensile tests. Unfortunately, it can be assumed that this precision cannot be achieved in standard tests with elastomers from classic rubber production. In addition, there are elastomers that tend to have larger scatter widths due to their compound structure or hardness levels. This effect was apparently deliberately excluded in the present study (no mention of the base elastomer or hardness of the compounds investigated).

⁶¹ DICK, John S.: Rubber Technology – Compounding and Testing for Performance, München, 2001, S.49

⁶² vgl. PAIGE, Ryan E. und MARS, Will V.: Implications of the Mullins Effect on the Stiffness of a Pre-loaded Rubber Component vorgetragen bei: 2004 ABAQUS Users' Conference, S.1f.
(Webseite abgerufen am 09.07.2014: <http://www.axelproducts.com/downloads/PaigeMars.pdf>)

⁶³ FREUDENBERG Forschungsdienste SE&Co. KG (Hrsg.), ohne Autorenangabe: MULLINS oder PAYNE? Zwei „starke Effekte der Gummielastizität“ in: FFD IM DIALOG, Ausgabe 2_2013, S.25 (Digital abgerufen am 09.07.2014: http://www.fnt-kg.de/pdf/FFDimDialog_2013_2.pdf)

⁶⁴ This term is defined as follows: „Die Präzision ist gemäß DIN ISO 5725 [1] definiert als „Ausmaß der gegenseitigen Annäherung zwischen unabhängigen Ermittlungsergebnissen, die unter festgelegten Bedingungen gewonnen sind.“ zitiert von: Amtl. Sammlung § 35 LMBG Statistik Mai 2003 „Planung und statistische Auswertung von Ringversuchen zur Methodvalidierung“, Seite 2, Dokument abgerufen am 18.09.2014: http://www.beuth.de/sixcms_upload/media/2359/lmbg35_mai_2003.pdf

Strength Categories	Repeatability Limit		Reproducibility Limit	
	r [N/mm ²]	r _{rel} [%]	r [N/mm ²]	r _{rel} [%]
Tensile Strength at Break x [N/mm²]				
22.4	2.5	11.2	2.6	11.6
31.9	1.3	4.1	1.9	6.0
33.8	5.2	15.4	5.3	15.7
Elongation at Break x [%]	r [%]	r_{rel} [%]	r [%]	r_{rel} [%]
390	27.5	7.1	53.1	13.6
537	55.6	10.4	76.8	14.3
671	57.4	8.6	97.2	14.5
Stress Value 100% x [N/mm²]	r [N/mm²]	r_{rel} [%]	r [N/mm²]	r_{rel} [%]
3.5	0.6	17.1	0.9	25.7
2.7	0.5	18.5	0.6	22.2
2.4	0.3	12.5	0.5	20.8

Tab.7: Repeatability and comparison limits for three different strength levels of elastomers ⁶⁵

In simplified terms, the repeatability limit r indicates the ranges between which the measured values can fluctuate if the same laboratory technician repeats the test on the same device with identical test material within one week.

The repeatability limit "r" expresses the fluctuations as absolute values. In practice, this means for the first case: an average tensile strength of 22.4N/mm² was determined. The repeatability limit "r" is 2.5N/mm². If the same tester measures identical material with the same instrument, the results of this interlaboratory test ranged from (22.4 - 2.5) N/mm² to (22.4 + 2.5) N/mm². The value "r_{rel}" indicates this range of variation in percent, relative to the initial value (here: 22.4N/mm²).

In the same simplified way, the comparison limit R here indicates the limit ranges between which the measured values can fluctuate if two different laboratory technicians perform in different laboratories with identical test material.

The reproducibility limit is almost always higher than the repeatability limit.

The results of interlaboratory comparisons, in which the O-ring test laboratory Richter regularly participates, show that there can be significant differences between tensile tests within different laboratories. There were some differences in the tensile strength results of +/-10%.

Typical deviations in tensile tests are between 2 and 10 % (standard deviation/average value) and can still be regarded as typical for rubber. The largest scatters are usually obtained with the elongation at break values, the smallest scatters with small modulus values (e.g. 100%). Hard materials (>85 Shore A) usually show significantly worse results than softer materials

⁶⁵ The data are taken from DIN 53504 (edition 2009-10): Prüfung von Kautschuk und Elastomeren – Bestimmung von Reißfestigkeit, Zugfestigkeit, Reißdehnung und Spannungswerten im Zugversuch, S.17

(50-70 Shore A). If these scatters exceed 15%, it is a clear indication of a manufacturing defect in the samples.

O RING

PRÜFLABOR

RICHTER

O-Ring Prüflabor Richter GmbH
Kleinbottwarer Str. 1
71723 Großbottwar

Telefon 07148 / 16602-0
Fax 07148 / 16602-299
info@o-ring-prueflabor.de
www.o-ring-prueflabor.de

Geschäftsführer:
Dipl.-Ing. Bernhard Richter
Ust-ID-Nr. DE 277600966
Steuer-Nr. 71342/02407 FA LB

Sitz der Gesellschaft:
Großbottwar
Amtsgericht Stuttgart
HRB 737482

Volksbank Ludwigsburg
IBAN DE96 6049 0150 0820 5810 03
SWIFT GENODES1LBG
